



Pulsar® Precision 30 High-Tech Commercial Pool Disinfection with Powerful Performance

The **Pulsar®** Precision 30 feeder is a high capacity erosion (HCE) feeder that is compact and lightweight with a modular design.







The feeder uses **Pulsar®** Plus Briquettes that produces a fresh concentrated liquid chlorine solution for clean and sanitized water. This innovative feeder system is easy to maintain and service with a flexible design that allows for easy integration for small to medium size commercial pools.

Switch to the **Pulsar®** Precision 30 Feeder System, delivering clear and sparkling water time and time again!









Certified to
NSF/ANSI/CAN 50

Powerful Feeder Performance

-  Booster Pump Optional
-  Provides consistent chlorine delivery
-  Feeder designed to minimize maintenance requirements
-  Injection molded components hold up to the strongest elements
-  Feeder design allows for easy access to internal components
-  Features high capacity erosion technology with the benefits of a venturi

Briquette Efficiencies

-  Won't overstabilize pool
-  More concentrated than liquid bleach
-  Dry, easy to handle formulation
-  Will not cause reduction of ORP
-  Highly concentrated to reduce shipping and handling costs
-  Longer shelf life when compared to liquid bleach



Pulsar® Precision 30

Secure lid locking feature

Briquette grid

Removable for easy maintenance

High capacity erosion nozzle

Emergency shut-off valve to prevent spills

Durable discharge valve

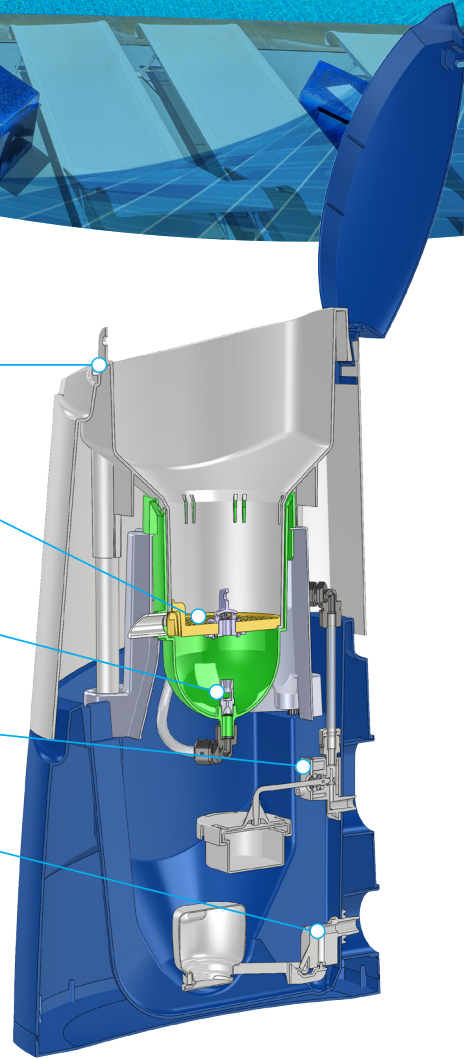

Recommended Pool Size (For guidance only)

Outdoor Non-Stabilized	Up to 50,000 gal.
Outdoor Stabilized	Up to 100,000 gal.
Indoor	Up to 150,000 gal.
Spas	Up to 10,000 gal.

Feeder Specifications

Width	15.5"	393.7 mm
Depth	19.5"	495.3 mm
Height	34.0"	863.6 mm
Water Inlet Size	1/2" MNPT	12 mm MNPT
Solution Outlet Size	1/2" MNPT	12 mm MNPT
Operating Weight	52 lbs	23.6 kg
Shipping Weight	20 lbs	9.1 kg
Dry Chemical Capacity	30 lbs	13.6 kg
Electrical		None
Operating Temperature	40°- 120° F	4.4°- 49° C

Chemical Specifications

Active Ingredient	Calcium Hypochlorite	
Available Chlorine	68%	
Scale Inhibitor	0.4-1.0%	
Weight	7-10g	
Dimensions (20g)	1.11" x 1.35" x .7"	28mm x 34mm x 17mm
Dimension (40g)	1.24" x 1.8" x .8"	26mm x 46mm x 20mm
Chemical Form	Pillow shaped briquette	
Color	White	
Container	50lb pail	22.6kg pail



www.pulsarsystems.net
1.800.4.PULSAR